

# new to range

# AYD<sup>®</sup>

AUTOMOTIVE INDUSTRY

THANKS TO AYD POWER AND ALL UNDER ONE ROOF STRATEGY



## AIR SPRING



### HENDRICKSON

#### AIR SPRING

#### SÜSPANSİYON KÖRÜĞÜ

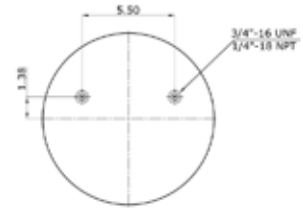

67-80718

OEM / COMPARISON NO

S25319-18\*\*SA

CROSS NO

1R14-152\*\*SA



### HENDRICKSON

#### AIR SPRING

#### SÜSPANSİYON KÖRÜĞÜ

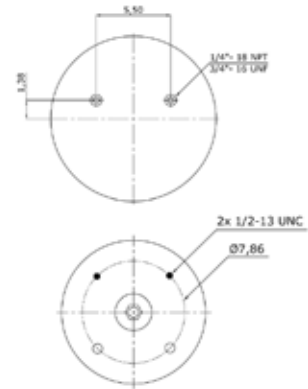
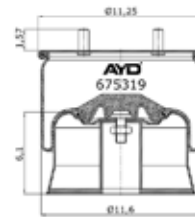

67-80600

OEM / COMPARISON NO

s25319-18

CROSS NO

1R14-152



### VOLVO

#### AIR SPRING

#### SÜSPANSİYON KÖRÜĞÜ

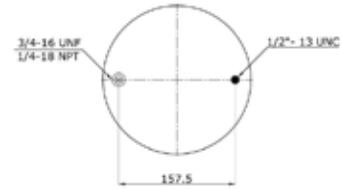
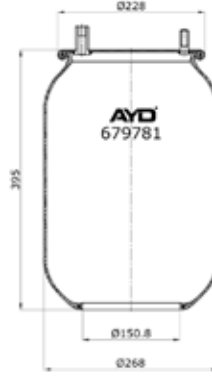

67-80597

#### OEM / COMPARISON NO

1615595  
1614004  
1613840

#### CROSS NO

1DF23-9781  
W01-358-9781  
1R12-603



### VOLVO

#### AIR SPRING

#### SÜSPANSİYON KÖRÜĞÜ

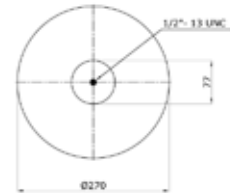
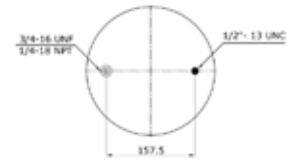

67-80597CAP

#### OEM / COMPARISON NO

1615595  
1614004  
1613840

#### CROSS NO

1DF23-9781  
W01-358-9781  
1R12-603



### VOLVO

#### AIR SPRING

#### SÜSPANSİYON KÖRÜĞÜ

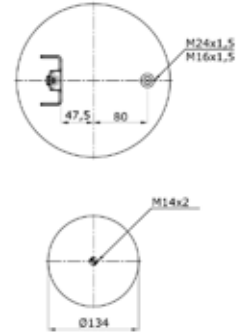

67-80260

#### OEM / COMPARISON NO

20737947-SA  
20583420-SA  
20737943-SA

#### CROSS NO

6614 N P01 (Without Piston)  
37947 P



### VOLVO

#### AIR SPRING

#### SÜSPANSİYON KÖRÜĞÜ

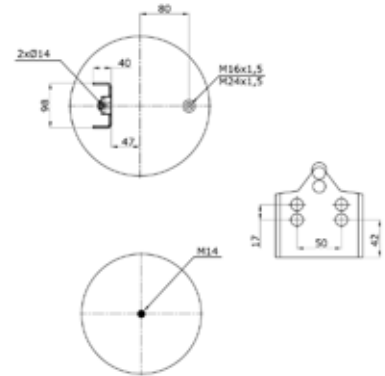
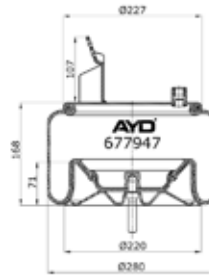

67-80523

#### OEM / COMPARISON NO

20737947  
20583420  
20737943

#### CROSS NO

6614 N P01  
37947 C

